

# Ductboard Fittings and Connections

## (Plenum)

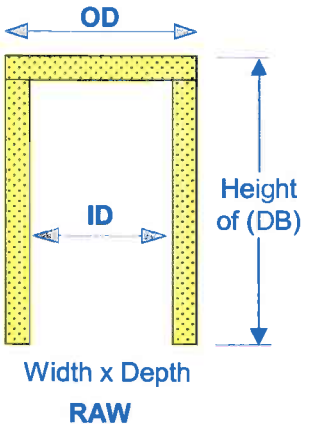

## (Duct)

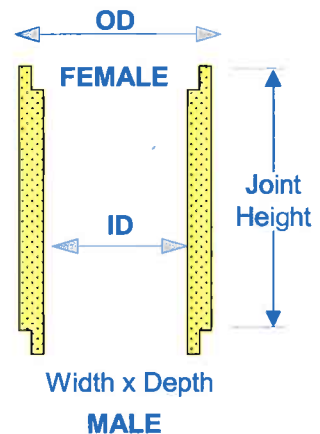

## (Cube)

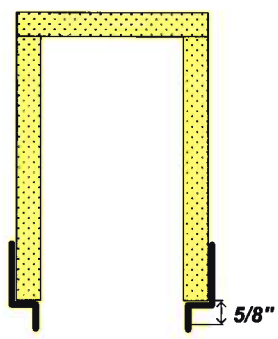
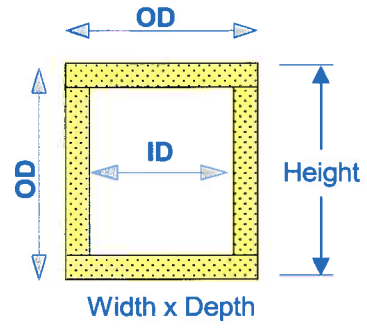

DBPG

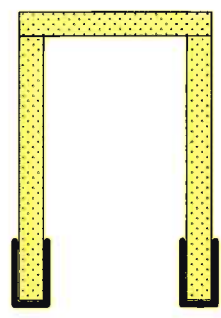

U-METAL

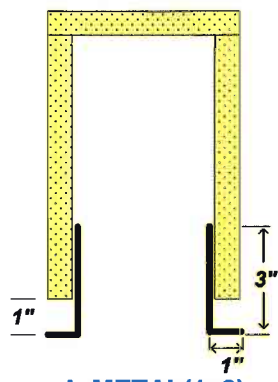

L-METAL(1x3)

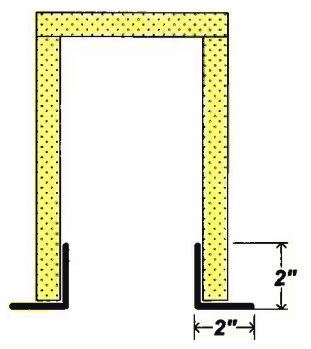

ANGLE(2x2)

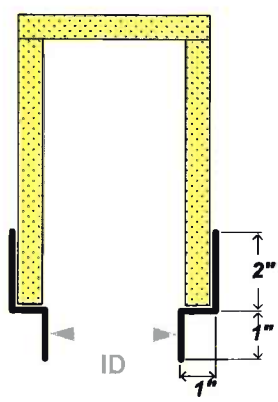

Z-BAR(1x1x2)

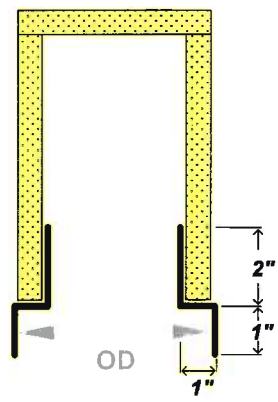

Z-BAR(1x1x2)

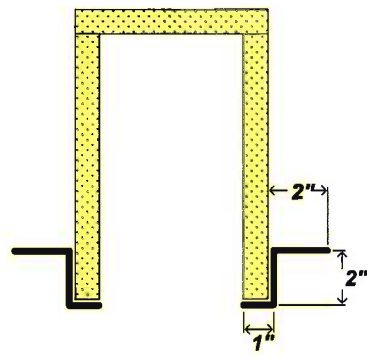

HANGER(2x2)

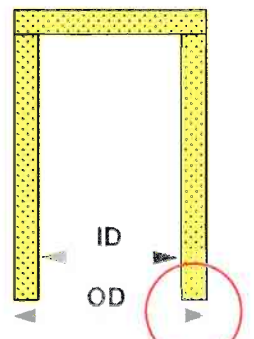

\*Special Connection

*Customer Provided Detail*